

TAP INNER STRENGTH

2024
OUTDOOR
BROCHURE



MOVESTRONG HISTORY TIMELINE

CELEBRATING 13 YEARS STRONG

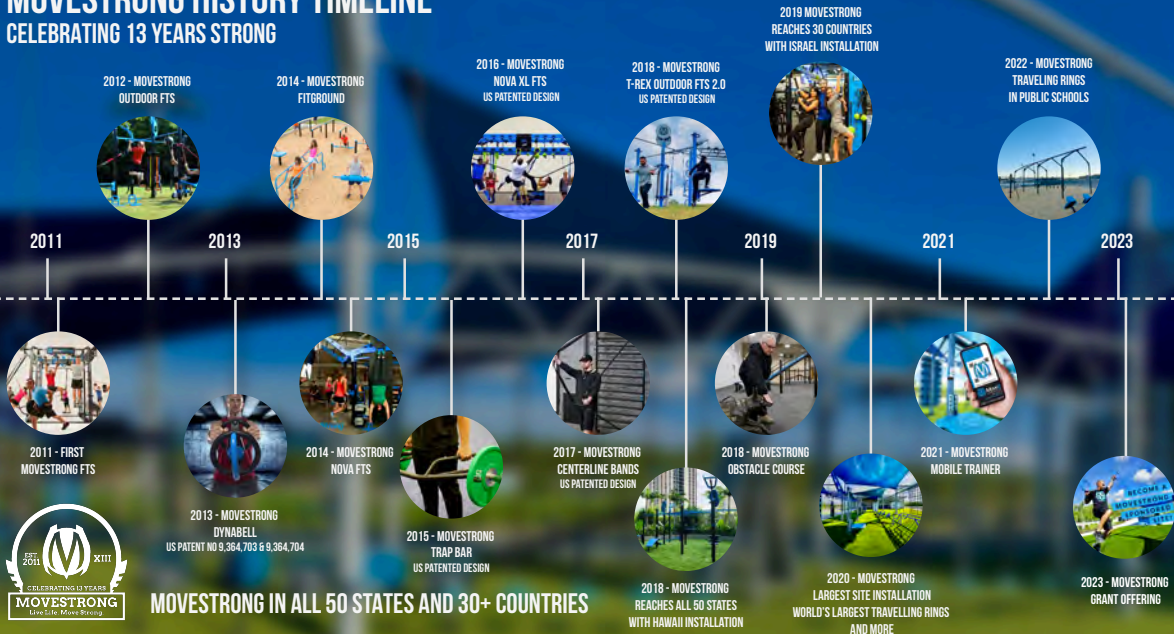

MOVESTRONG IN ALL 50 STATES AND 30+ COUNTRIES



TABLE OF CONTENTS



T-REX TRAINING STATION

FITGROUND

OBSTACLE COURSE

SPECIALTY TRAINING

FREE WEIGHTS & STORAGE

ACCESSORIES

SURFACING & SHADE

EDUCATION



OUTDOOR FUNCTIONAL TRAINING STATION



AVAILABLE POST COLORS

VISIT WWW.MOVESTRONGFIT.COM/BYO



Note: not all colors are available for the T-Rex kickplate, ab bench, step attachment, and the fitground plyo steps. These products are coated with polyurea or pvc coating colors choices: black, gray steel, sky blue, red, dark blue, dark green, and brown.



WEAR PARTS: POLYUREA COATING FOR LONGER DURABILITY AND PROTECTION FROM THE ELEMENTS

OPTIONAL PULL-UP AND DIP BAR POLYUREA COATING



T-REX ADJUSTABLE DIP US PATENTED ADJUSTABLE TRAINING FEATURES DIP, STEP, AB BENCH

PATENT NO. D941407

SEE THE T-REX BROCHURE
FOR MORE INFORMATION



FITNESS STATION™
MoveStrong Outdoor
Functional Training Station

T-Rex 2 post



T-Rex In-line



T-Rex 10 post



T-Rex 6 post
Elite

T-Rex configurations and unique
optional features.

T-Rex 4 post



T-Rex 6 post



T-Rex 8 post



MoveStrong®
Functional Fitness Equipment
www.MoveStrongFit.com

T-Rex POST Elite

FITNESS STATION™

1. STANDARD POST w/ EXTENSION HANGER & HEAVY BAG
2. EXTENDED PULL-UP BAR
3. STANDARD POST w/ ADJ. DIP
4. SQUAT RACK
5. OMNI STRENGTH BAR
6. BATTLE ROPE
7. SIDE RAIL PULL-UP BARS
8. MONKEY BAR BRIDGE w/ LOWER RAILS
9. LOOP POST w/ SINGLE MEDICINE BALL TARGET
10. KICK PLATE POST, Y-EXTENDER & ELEVATE ROPE TRAINER
11. CLIFF HANGER
12. GLOBE GRIPS
13. STANDARD POST w/ ADJ. STEP
14. CLIMBER BARS
15. STANDARD POST w/ ADJ. AB BOARD

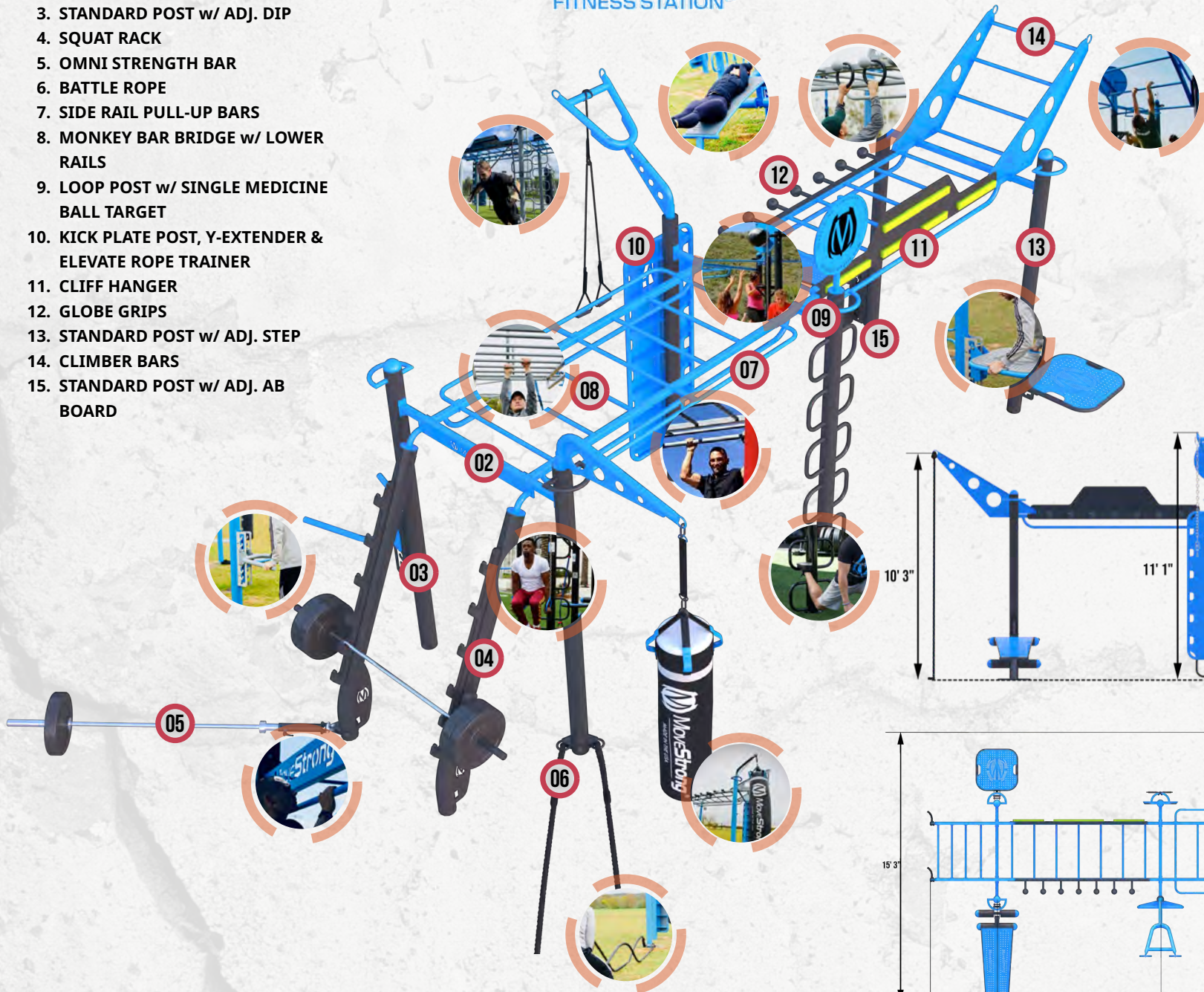

SIDE VIEW

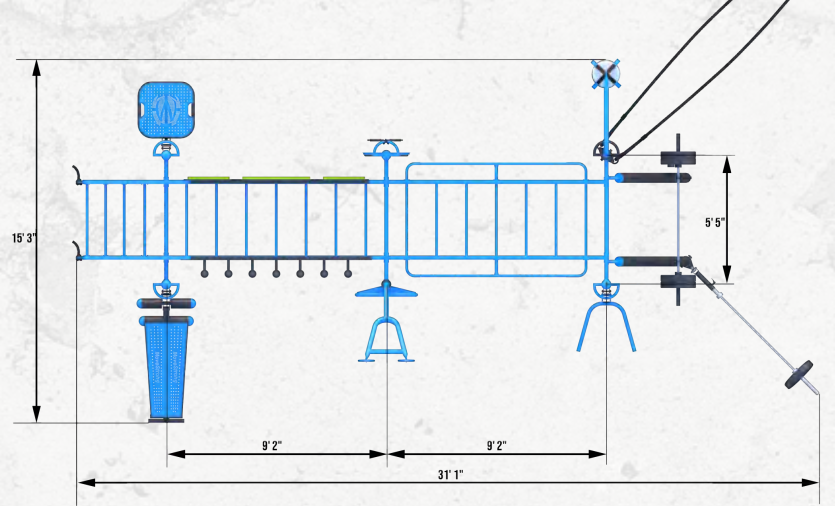
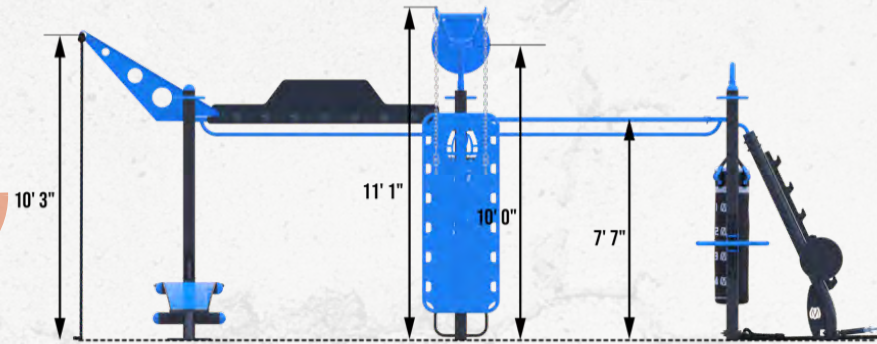

TOP VIEW

6-POST ELITE



2024 FITGROUND BROCHURE





CUSTOMIZE AND BUILD A FITGROUND FOR YOUR SPACE AND TRAINING NEEDS. SEE ALL THE ACCESSORIES!

CARGO NET WITH ROPE CLIMB STATIONS - VARIOUS SIZES AVAILABLE



**ZIG-ZAG
BALANCE BEAMS**



PLYO-STEPS

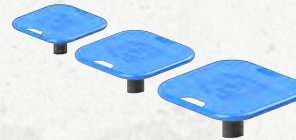

PUSH-UP / INVERTED ROW BARS



LOW PARALLEL BARS



BALANCE STEPS

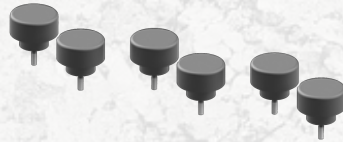

STALL BARS



LOW ANGED CARGO NET

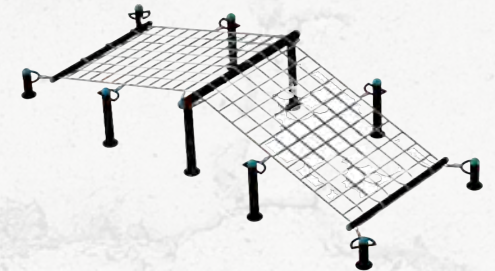

ELEVATE TRAINER STATION



BATTLE ROPE STATION



ELITE PARALLEL BARS



A-WALL CLIMBER



OVER / UNDER HORIZONTAL POST



FARMER LOGS



DRIVE SLED



FITGROUND



ELEVATE TRAINER STATION

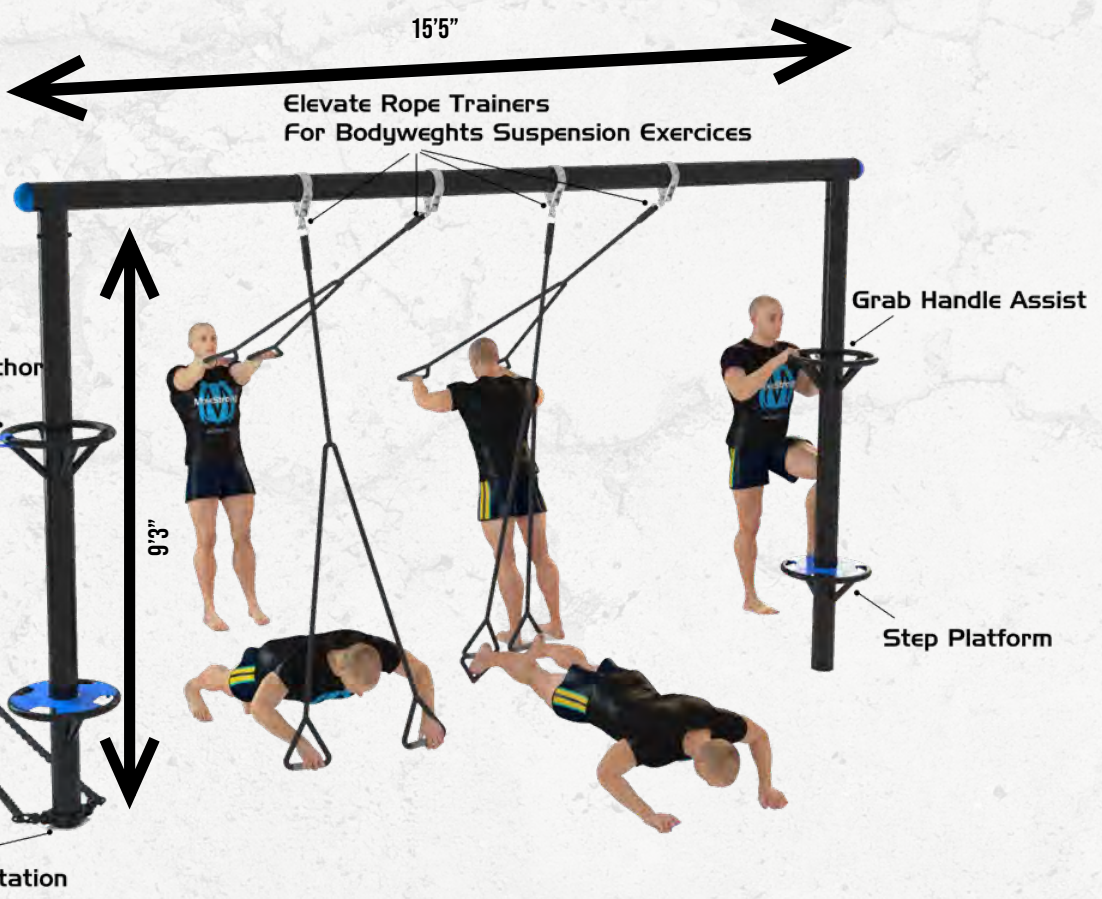

FITGROUND

ZIG-ZAG BALANCE BEAM

The Zig-Zag Balance Beam allows for many bodyweight exercises to improve balance and stability.

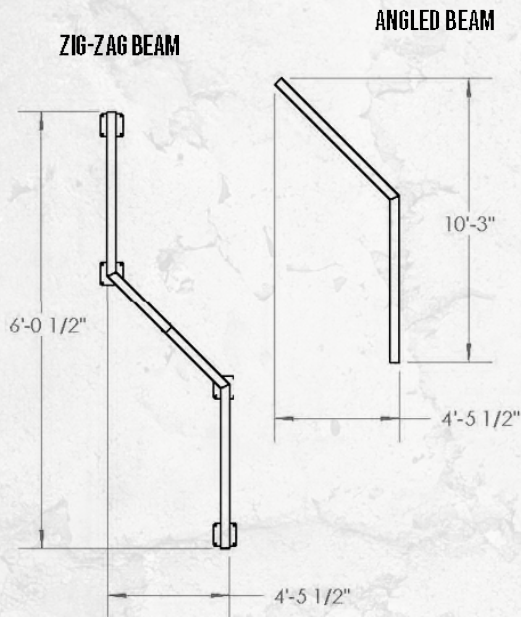

BALANCE STEPS

Focus on balance and agility with the Balance Steps. Configure your FitGround area with different quantities and patterns to fit layout and exercise needs.

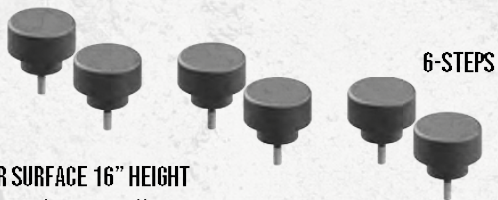

12" DIAMETER SURFACE 16" HEIGHT
Varying height install options

Rubber surface step allows for slight tilting for feedback on balance



FITGROUND



BATTLE ROPE STATION

OUTDOOR RATED ROPES

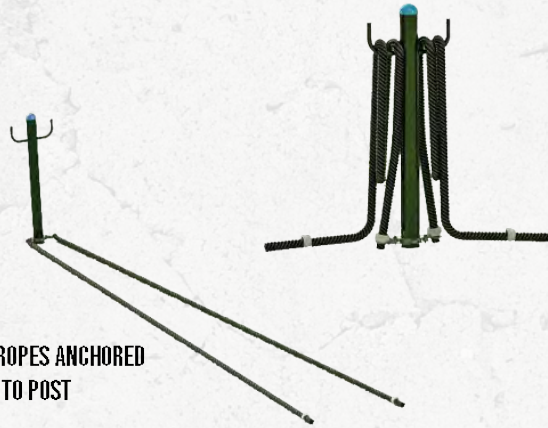

BATTLE ROPES ANCHORED TO POST



PLYO-STEPS

Varied height Plyo-Steps are great for improving agility, flexibility, power, and for building athleticism.

3 HEIGHTS AVAILABLE 12", 18", 24"



2'-4 5/8" TYP

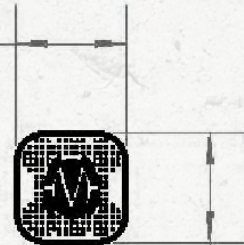

2'-4 5/8" TYP

FITGROUND

LOW PARALLEL BARS

The Low Parallel Bars are ideal for upper body, agility, and balance exercises.



10" LENGTH AND 12" HEIGHT.
INQUIRE ABOUT OTHER OPTIONAL SIZES



LOW ANGLED CARGO NET

Great obstacle course style station with an up-and-over crawl on top of the low height angled cargo net. Develop balance, strength, and coordination skills with this fun challenging obstacle.

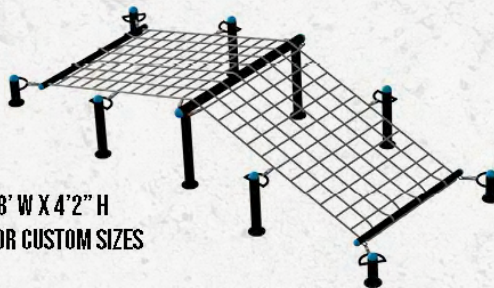

18'4" L X 8' W X 4'2" H
CONTACT US FOR CUSTOM SIZES



FITGROUND



PUSH-UP/INVERTED ROW BARS

Build upperbody and core strength with the varied height Push-Up Bars. Two height bars ideal for push-up variations and inverted rows. Lower bar offer varied hand grip positions.

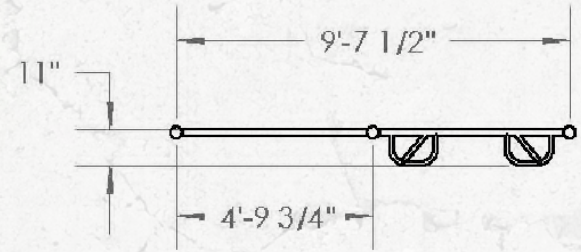

ELITE PARALLEL BARS

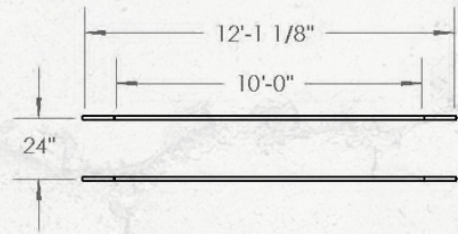

CARGO NET

Use for functional fitness, climbing, bodyweight, and obstacle course training. Offers two optional rope climb stations as well.

10' CARGO NET FRAME HEIGHT.
INQUIRE ABOUT OTHER HEIGHT OPTIONS.

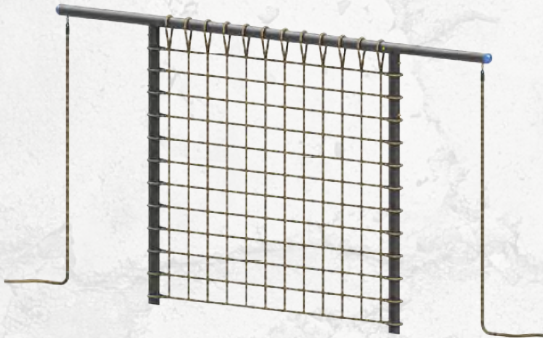
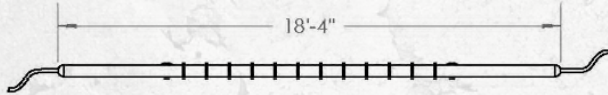

A-WALL CLIMBER

The A-Wall Climber is a great FitGround addition to create a challenging up and over climb. Climbing rope to grasp and assist on climb up and over the step angle wall.



8' OVER HEIGHT. INCLUDES CENTER GRAB ROPE.



FITGROUND

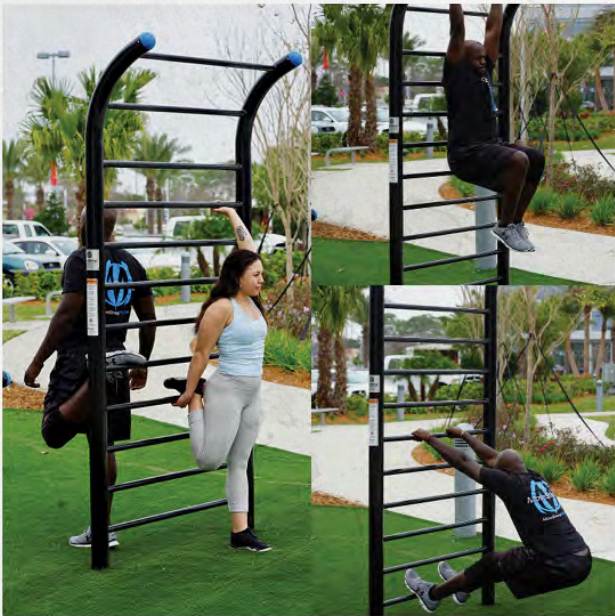

STALL BARS

Dedicated flexibility and stretching station. Varied height rungs to assist in flexibility and bodyweight exercises. Arched top bar for hangs and pull-up variations.

STALL BAR DIMENSIONS ARE 4' WIDE X 8' TALL



OVER/UNDER HORIZONTAL POST

The Over/Under posts are great for agility, balance, and strength training.

AVAILABLE IN 3 HEIGHT OPTIONS: 24", 36", 48"

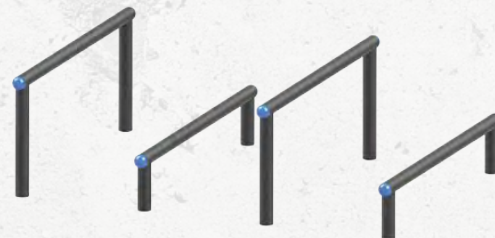
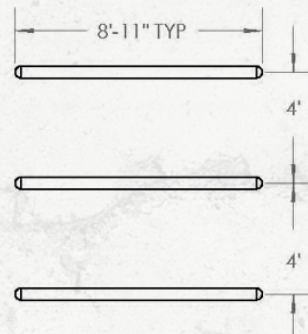

FITGROUND

MoveStrongFit.com

2024 OBSTACLE COURSE BROCHURE



OUTDOOR OBSTACLE COURSE



BUILD CONFIDENCE AND TEAMWORK

Obstacle course training is an excellent way to gain confidence as users get stronger and more confident with each run through the course. Work together as a team to encourage others and compete against each other for friendly competition and bonding as a group. A great social activity since others will experience all the same challenges together. Use obstacle course training to build stronger friendships and develop a support system among teams and co-workers.

IMPROVE ENDURANCE, STAMINA, AND FUNCTIONAL STRENGTH

OC Training is a great way to get heart healthy with cardiovascular exercise, build real usable functional strength and athletic muscle mass while and burning body fat all at the same time.

BREAK THE BOREDOM

break the normal gym routine with some fresh air and MoveStrong OC Training. A fun challenging way to incorporate new workouts sure to help break the norm of traditional machine gym workouts that will no doubt yield new results in your athletic, physical, and body composition results!

INCREASE FLEXIBILITY & AGILITY WITH IMPROVED BALANCE

Climb, crawl, run, jump, balance, and swing your body through a variety of obstacles. Move in manners the body was intended! You will quickly become more agile and improve those athletic skills with obstacle training. Over time, you'll get better and more energy efficient with improved work capacity as you learn how to overcome obstacles more efficiently and preserve energy to make it all the way across the finish line without running out of steam.

OBSTACLE COURSE



PUT PHYSICAL CHALLENGE AND COMPETITION TO THE TEST WITH THE MOVESTRONG OBSTACLE COURSE! CUSTOMIZE AND BUILD A COURSE TO FIT YOUR SPACE AND TRAINING NEEDS.



OBSTACLE COURSE

OC SAMPLE LAYOUTS



COMPLETE OBSTACLE COURSE



OBSTACLE COURSE

OC STATIONS

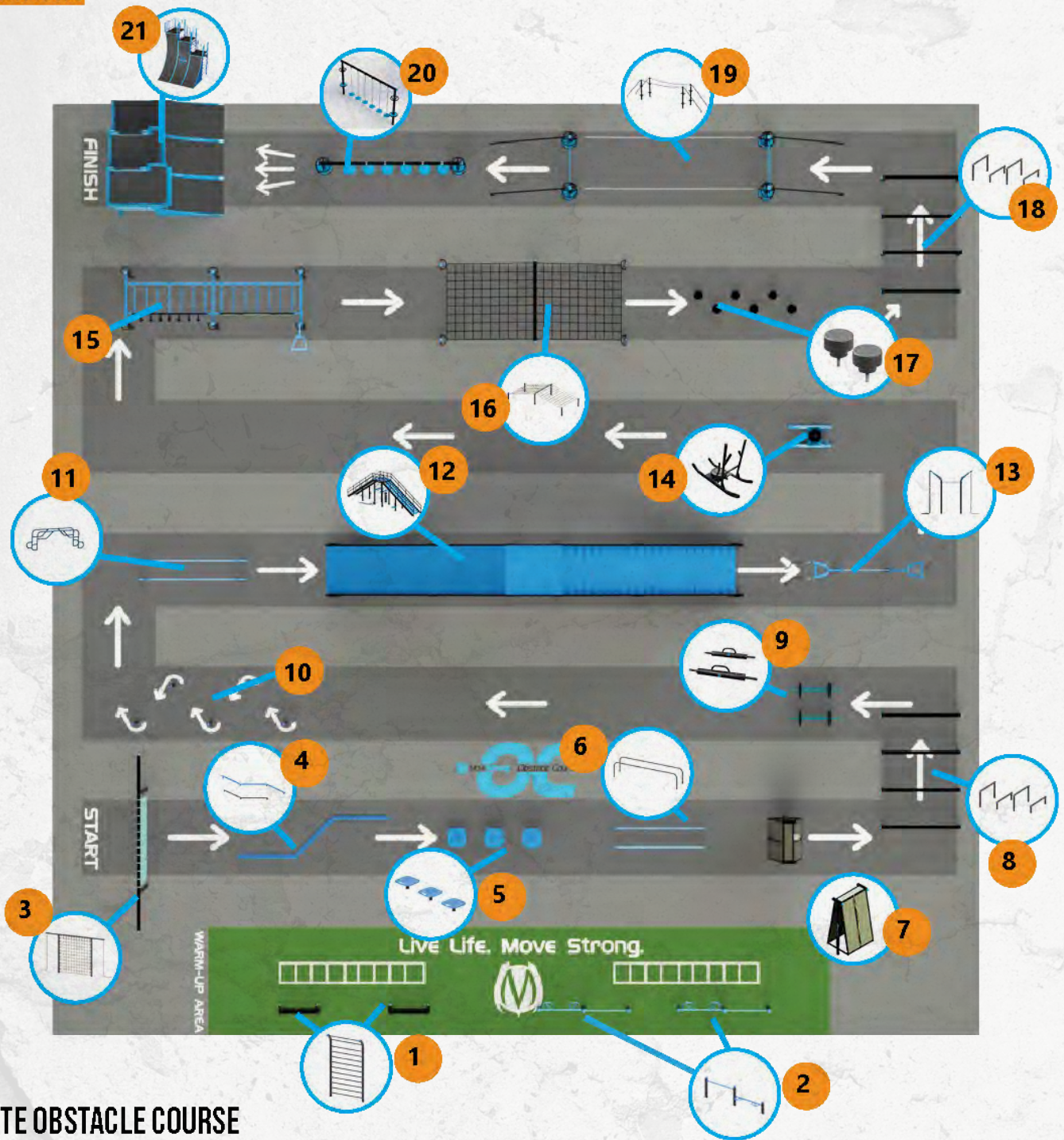

COMPLETE OBSTACLE COURSE

- | | | |
|--------------------------------|----------------------------------|---------------------------------------|
| 1. Stall Bars | 9. Log Carry | 17. Balance Steps |
| 2. Push-Up/Inverted Row Bars | 10. Slalom Agility Posts | 18. 36" & 48" Over/Under Agility Post |
| 3. Cargo Net Rope Climb | 11. Parallel Bar Upper Body Walk | 19. Horizontal Rope Climb |
| 4. Zig-Zag Balance Beam | 12. Obstacle Staircase | 20. Swinging Balance Steps |
| 5. Plyo Step Jumps | 13. Rope Climb Station | 21. Triple Warped Wall |
| 6. Low Parallel Bar | 14. Drive Sled Push | |
| 7. A-Wall Climber | 15. 6-Post T-Rex | |
| 8. 24" Over/Under Agility Post | 16. Low Cargo Net Climb | |

OBSTACLE COURSE

HORIZONTAL ROPE CLIMB



20' HORIZONTAL ROPE TRAVERSE

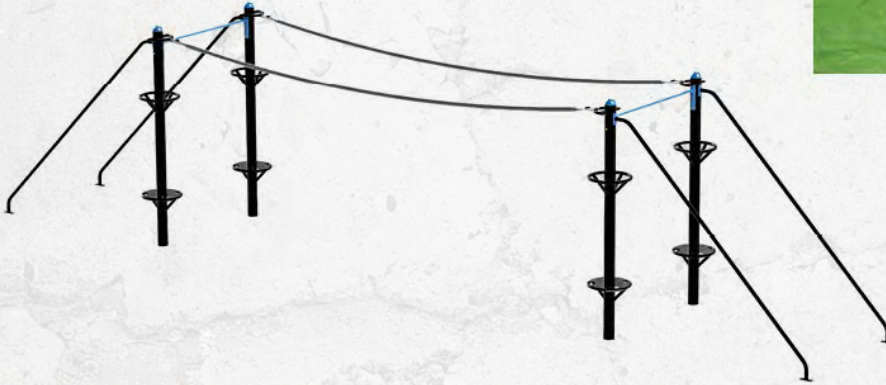

DUAL ROPE CLIMB

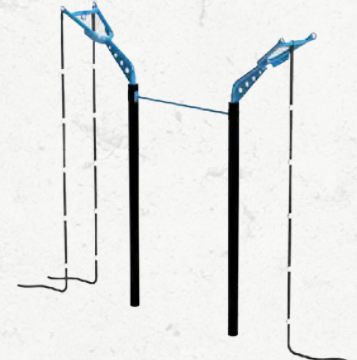
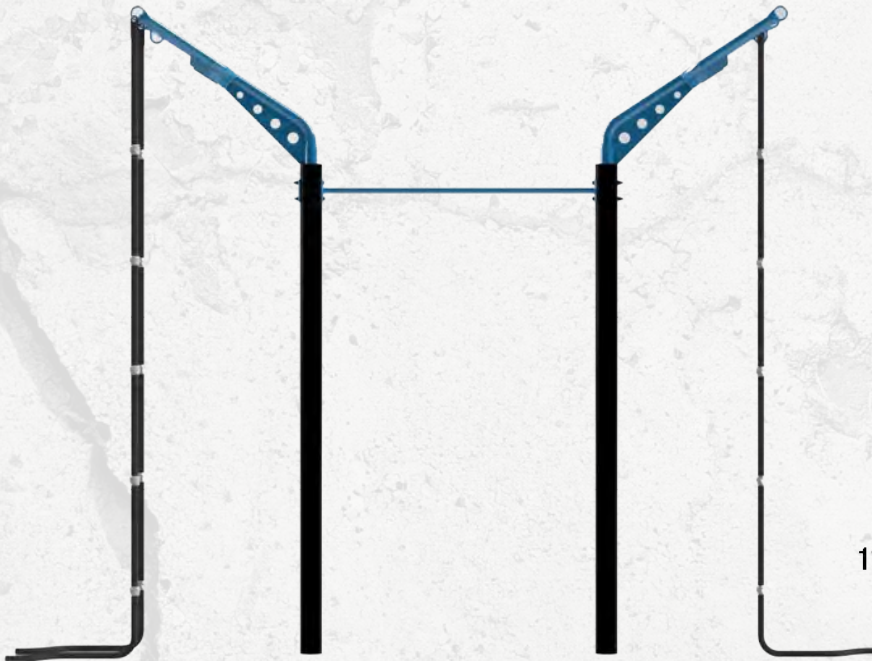

11' DUAL OR SINGLE ROPE CLIMB WITH CENTER HANG BAR

OBSTACLE COURSE

20' CARGO NET AND ROPE CLIMB

20' ROPE CLIMB WITH BELL RING OPTION

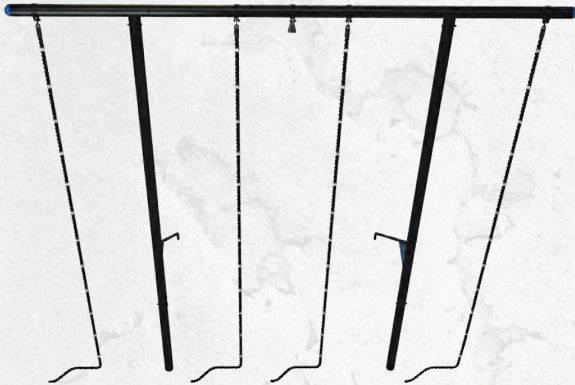

COMBO ROPE CLIMB CARGO NET WITH BELL RING OPTION

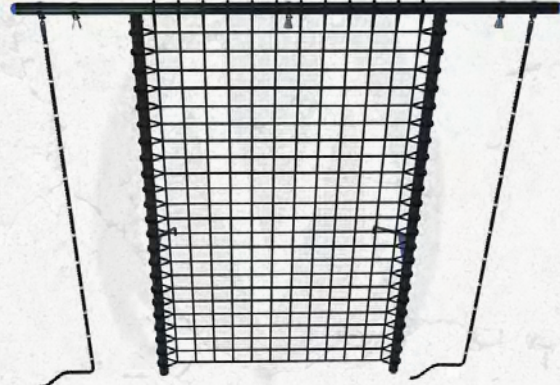

QUINTUPLE STEPS

Great obstacle course style station with an up-and-over crawl on top of the low height angled cargo net. Develop balance, strength, and coordination skills with this fun challenging obstacle.

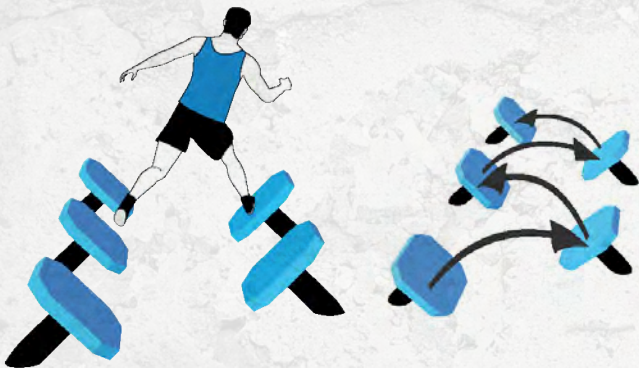

AGILITY CRAWL NET

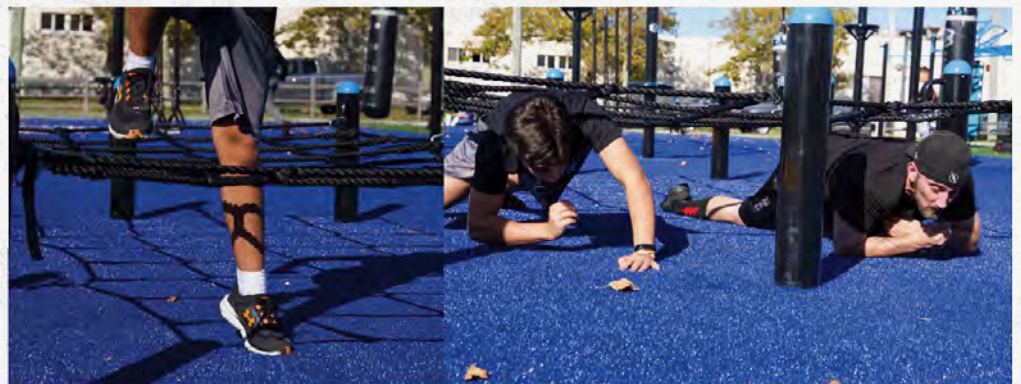

OBSTACLE COURSE

HANGING OBSTACLES



HANGING BALANCE

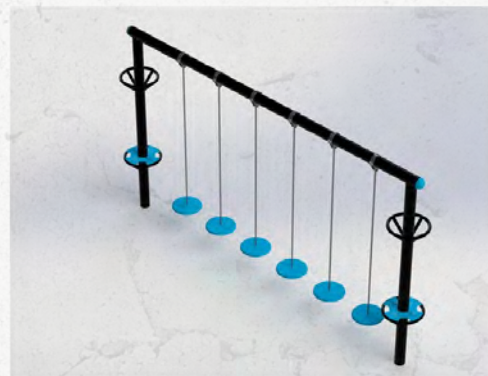

DOWEL GRIPS



RING TRAVERSE

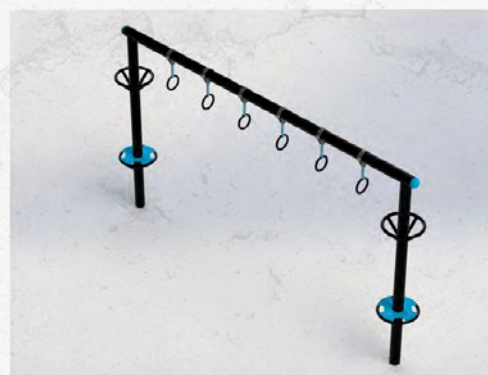

OBSTACLE COURSE

WARPED WALL



8' WALL



TRIPLE WARPED WALL

- 8', 12', and 14' Warped Walls
- Backside Training Features and Options
- Optional Top Safety Rails



CUSTOM BACKSIDE CARGO NET OPTION

OBSTACLE COURSE

SLACKLINING ANCHOR POSTS



***SLACKLINE NOT INCLUDED.**

SLALOM AGILITY POSTS

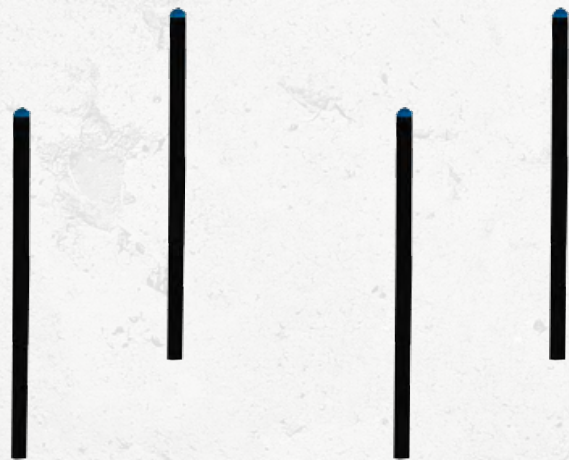

OBSTACLE COURSE

WALL OBSTACLE

6' & 8' WALL OBSTACLE INGROUND AND SURFACE MOUNT

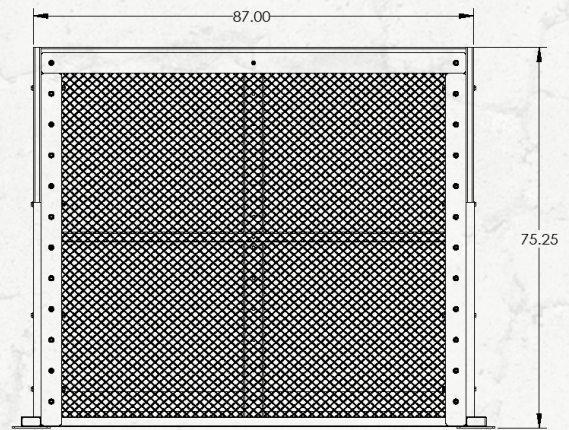
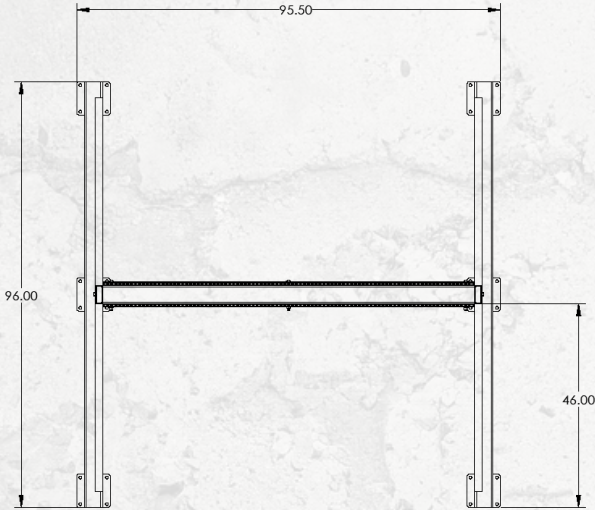
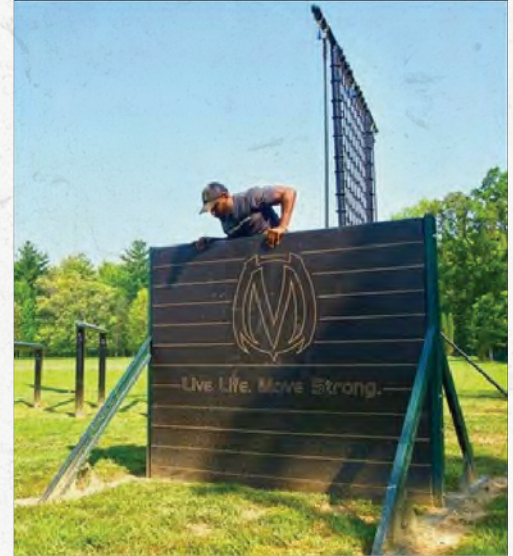

6' & 8' CHAIN LINK WALL OBSTACLE



OBSTACLE COURSE

CUSTOM / SPECIALTY TRAINING EQUIPMENT

Build a specialty training solution to suit your training program needs.

MoveStrong
Staircase & Ramp
Functional & Obstacle Course Training



LONG STAIRCASE MODEL

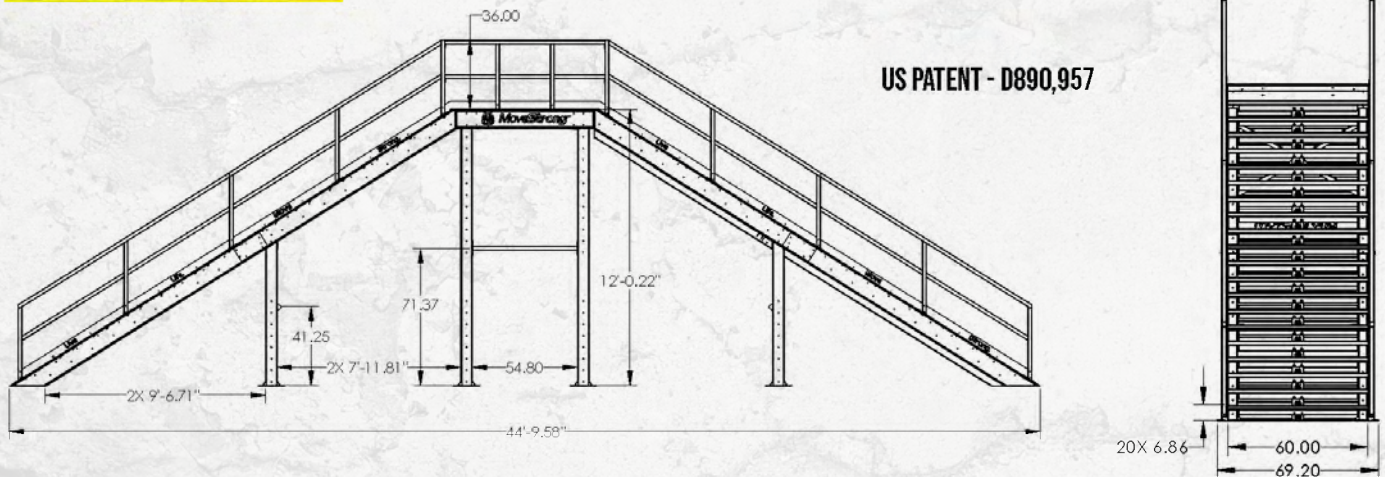

OBSTACLE STAIRCASE



OBSTACLE STAIRCASE WITH RAMP



CONFIGURE WITH OPTIONAL TRAINING FEATURES UNDER STAIRCASE

*DESIGN PATENT PENDING

SPECIALTY TRAINING

PINNACLE STAIRCASE MODULAR DESIGN

Customize with obstacles on all 4- sides of the Long Staircase. Warped Wall and cargo nets shown.

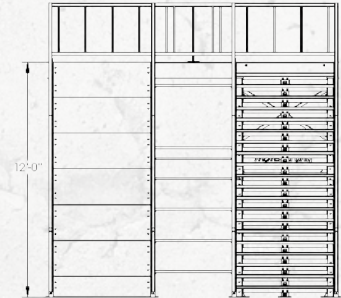
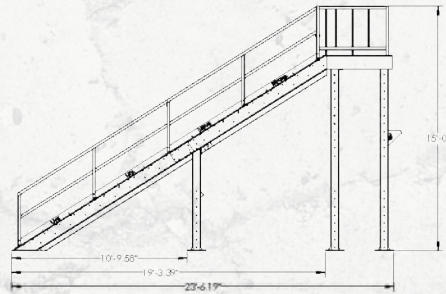
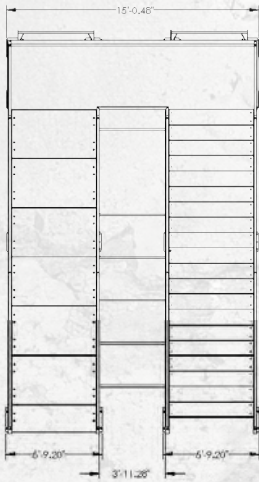
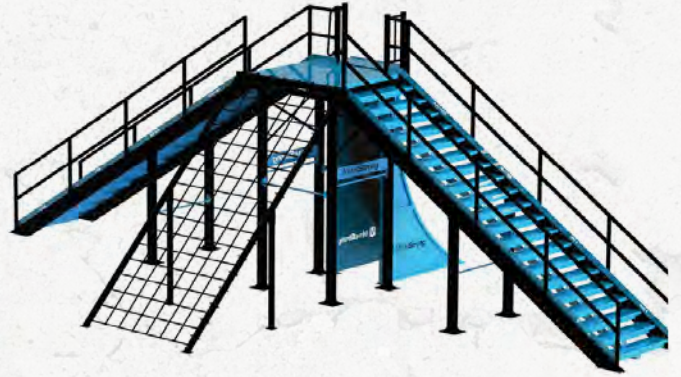

U-STAIRCASE TRAINING OPTIONS

1. KickPlate w/ Medicine Ball Target and Storage
2. Squat Stands
3. Pull-Up Bar With Medicine Ball Logo Plate
4. Dual Height Pull-Up Bar
5. Battle Rope Anchor
6. Push-Up Bar
7. Climbing Rope
8. GRT (Ground Rotational Trainer)



NEW STORAGE OPTIONS
AVAILABLE UNDER STAIRS

SPECIALTY TRAINING

U-STAIRCASE OPTIONAL OPTIONS

- 9. Adjustable Dip
- 10. Adjustable Step
- 11. Diamond Medicine Ball Target
- 12. Olympic Plate Storage



TRAVELING RINGS

WANNA FLY!? OUR TRAVELING RINGS ARE DESIGNED TO CREATE THAT FEELING!



Traveling Rings

TRAVELING RINGS - STANDARD

MODULAR IN LENGTH

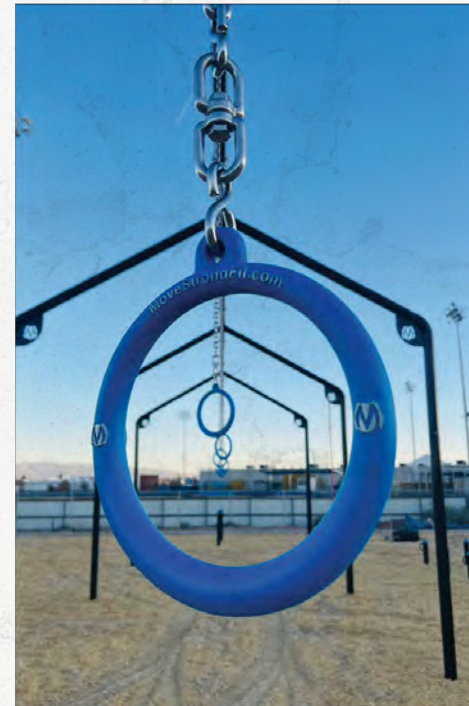
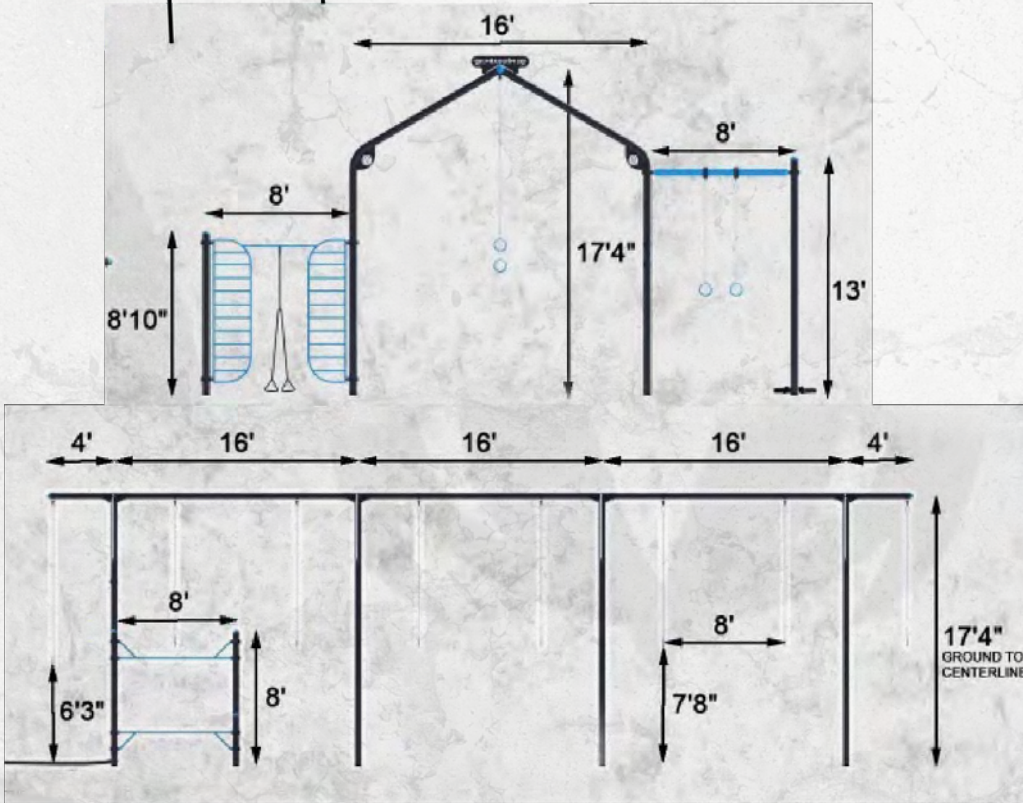

1. Traveling Rings

MODULAR TRAINING OPTIONS

- 2. Pull-Up Bar
- 3. Push-Up Bar
- 4. Ladder Bars
- 5. Outdoor Elevate Trainer
- 6. Fitness Rings
- 7. Battle Ropes



SPECIALTY TRAINING

OUTDOOR STRENGTH & STORAGE



GET ORGANIZED WITH OUR COMPLETE ASSORTMENT OF FREE-WEIGHT/ACCESSORY STORAGE RACKS AND MULTI-PURPOSE SQUAT, BENCH, PULL-UP RACKS. VISIT OUR WEBSITE FOR MORE DETAILS.

MODULAR OUTDOOR DB & ACCESSORY STORAGE RACKS

NEW

PATENT PENDING

*ACCESSORIES NOT INCLUDED

GLOBE BARBELL
(SOLD SEPARATELY)

SLEDGEBELLS
(SOLD SEPARATELY)

BATTLE ROPES
(SOLD SEPARATELY)

STORAGE RACK FEATURES

1. Flat Kettlebell
2. Dumbbell Tray
3. Cable Lockdown Holes
4. Battle Rope Anchor
5. Lockdown Bar
6. Vertical Accessory Storage Bay

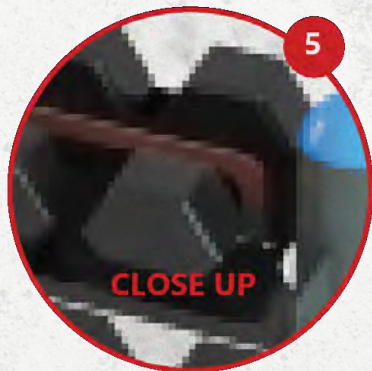
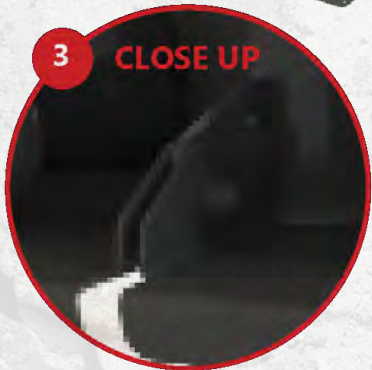

SINGLE BAY

STORAGE



FREESTANDING FUNCTIONAL SQUAT RACK

ALSO AVAILABLE AS A
TREX FTS ATTACHMENT

*ACCESSORIES NOT INCLUDED

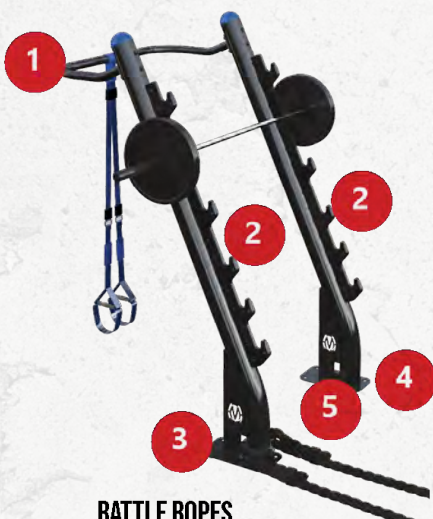
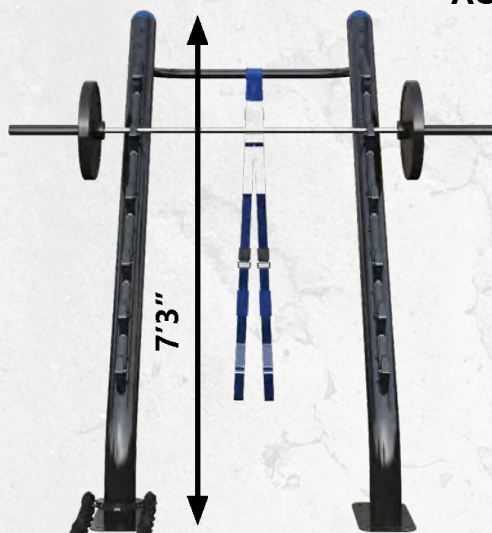

BATTLE ROPES
(SOLD SEPARATELY)

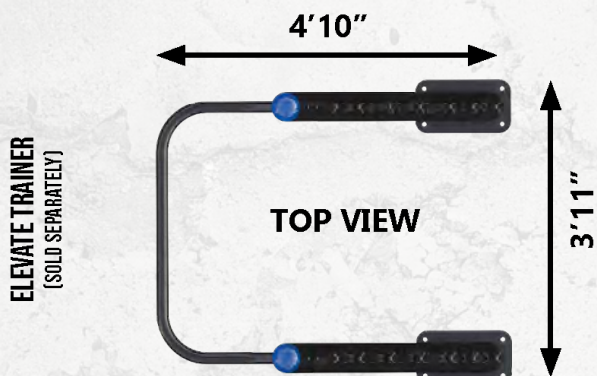

FREESTANDING FUNCTIONAL SQUAT RACK FEATURES

1. Pull-Up Bar
2. Wear Guard Inserts
3. Base Attachment Options (Both Posts)
4. Surface Mount or In-Ground Anchoring
5. GRT (Landmine) Attachment

OUTDOOR DUMBBELL FLAT BENCH

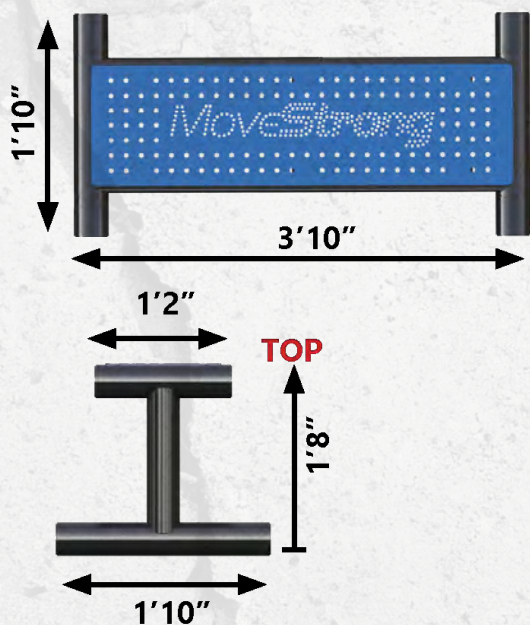

STORAGE LOCKER

NEW

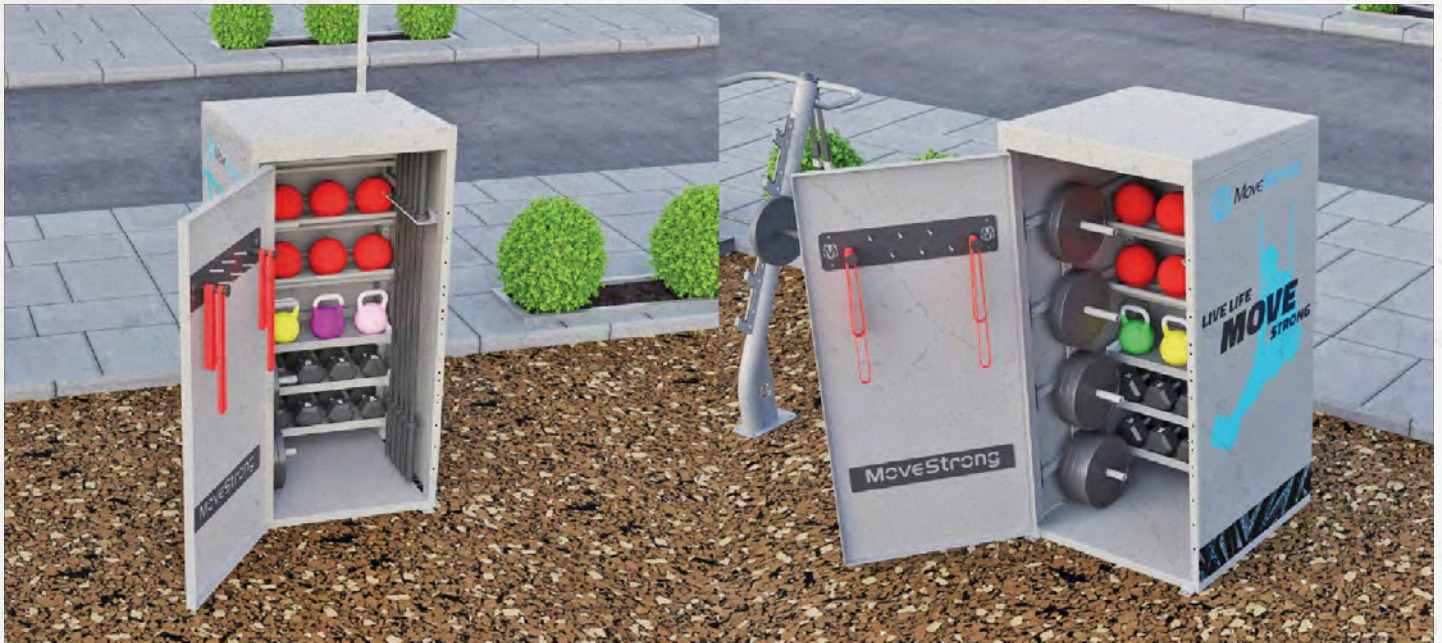

TRAINING LOCKER FEATURES

1. Hanging Pegs
2. Weight Plate Storage
3. Medicine Ball, Kettlebell, and Dumbbell Storage
4. Weight Bar Storage



STORAGE

OUTDOOR TRAINING TOOLS



DRIVE SLED

Do more with a Drive Sled for strength and conditioning!

GLOBE BARBELL

Specifically designed for year round outdoor use, our fillable Globe Barbell is an excellent strength tool.

SLEDGEBELL

Specifically designed for year round outdoor use, our fillable SledgeBell is an excellent strength tool.



KETTLEBELL



RHINO BAG



OUTDOOR HEAVY BAG

Built to last, 100lb Heavy Bag USA Made. Commercial quality design weather resistant for use in an outdoor setting. Great for personal/group training workouts by adding call-out targets for coaches and clients to use in varying targeted blows to the bag. Top bag grab handles to delivery a more powerful knee to your targeted area.

ACCESSORIES



*Weight plates not included.

FARMER'S WALK LOG

Designed for outdoor use in the FitGround, our Farmers Walk Logs are a fun way to build strength and endurance for loaded carries. Add weight in the fill hole of the log and/or traditional Olympic weight plates on the end holders.



FUNCTIONAL TIRE

80kg & 120kg size functional training tires for outdoor use. Ground anchors available to keep tires in fixed area to prevent removal.



CLIMBING ROPE



OUTDOOR RINGS



BATTLE ROPES



ELEVATE ROPE TRAINER

MADE IN USA. Designed for outdoor use. Outdoor rope material will not absorb water. Perform bodyweight suspension exercises. Press, row, lunge, squat, and twist with many variations for all fitness levels. Easily attach to the MoveStrong T-Rex top post loop or extension hangers.

ACCESSORIES

PERFORMANCE SURFACE AND SHADE SOLUTIONS

SURFACES

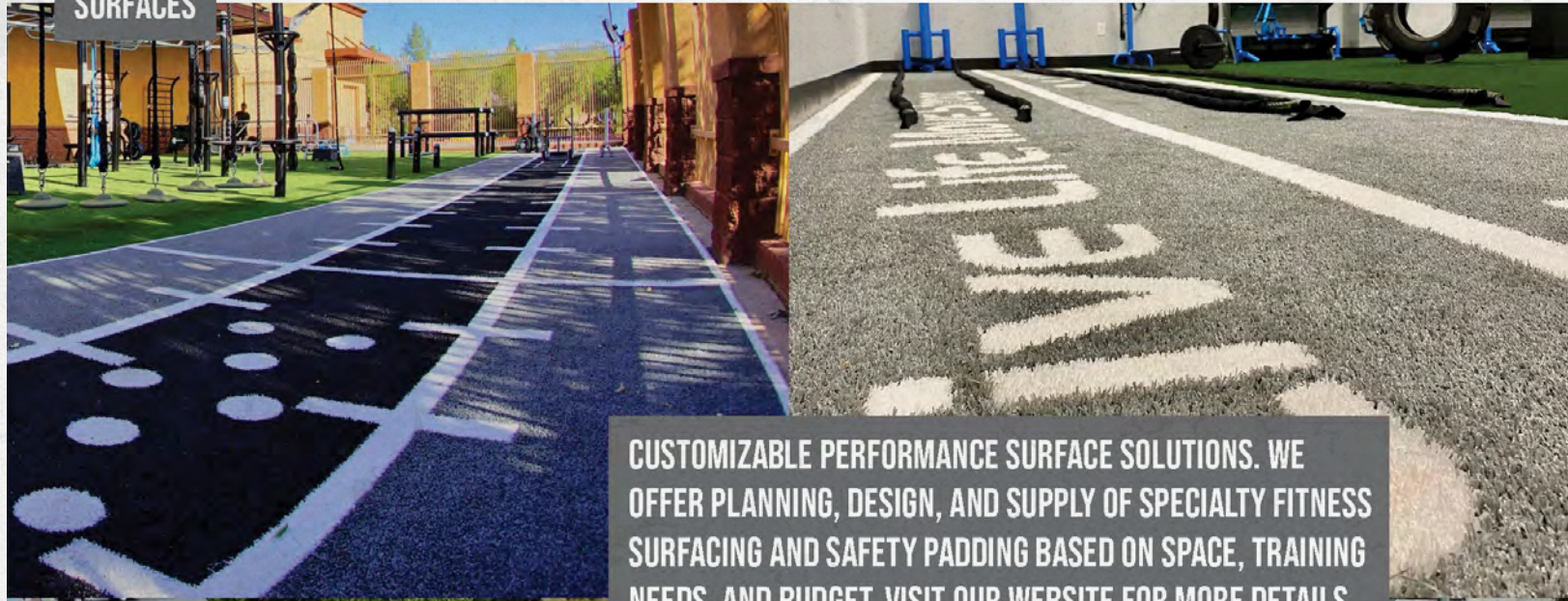

CUSTOMIZABLE PERFORMANCE SURFACE SOLUTIONS. WE OFFER PLANNING, DESIGN, AND SUPPLY OF SPECIALTY FITNESS SURFACING AND SAFETY PADDING BASED ON SPACE, TRAINING NEEDS, AND BUDGET. VISIT OUR WEBSITE FOR MORE DETAILS.

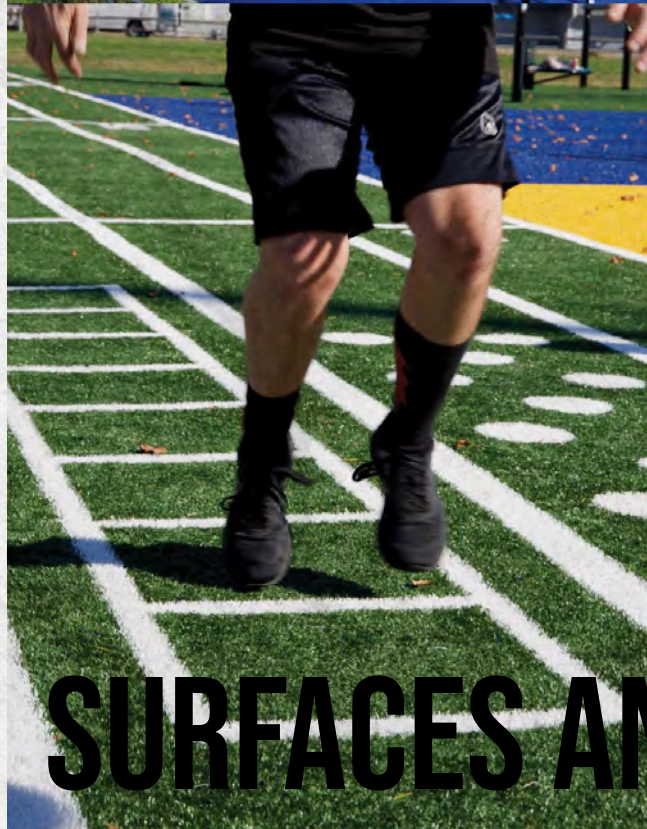

SURFACES AND SHADE

FURTHER FITNESS FUNCTIONALITY WITH TURF TRAINING GRAPHICS

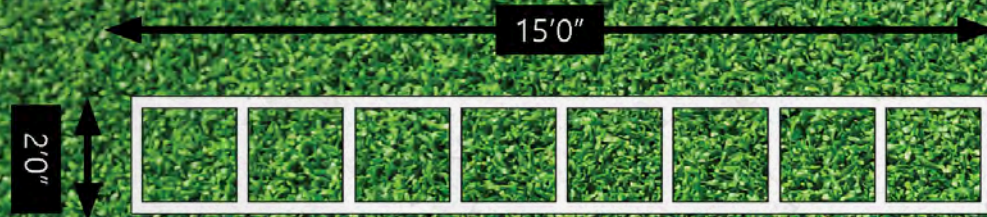

AGILITY LADDER

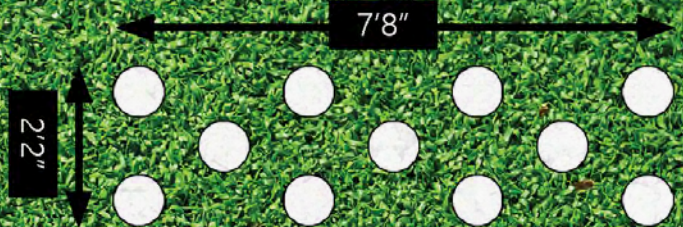

AGILITY DOTS

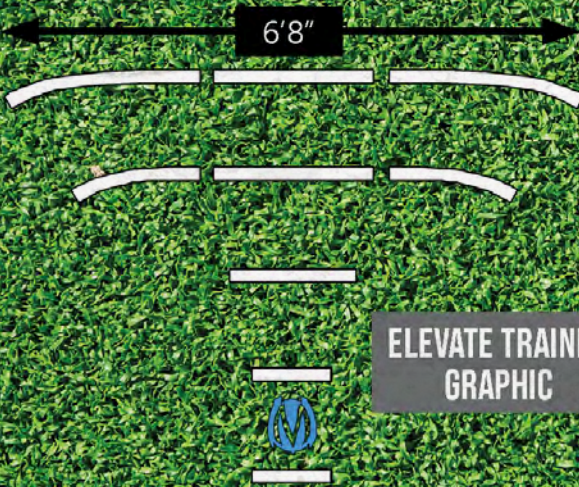

ELEVATE TRAINER GRAPHIC

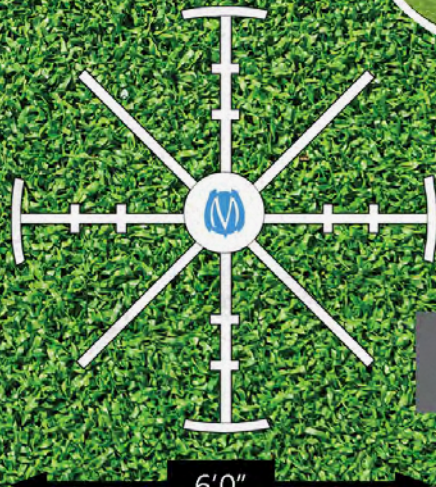

AGILITY COMPASS



6' TRAINING ZONE

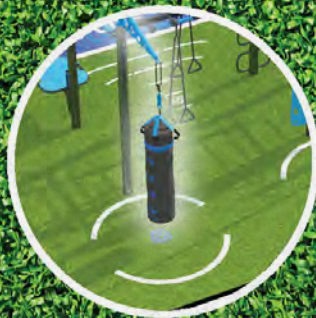

SHADE SOLUTIONS

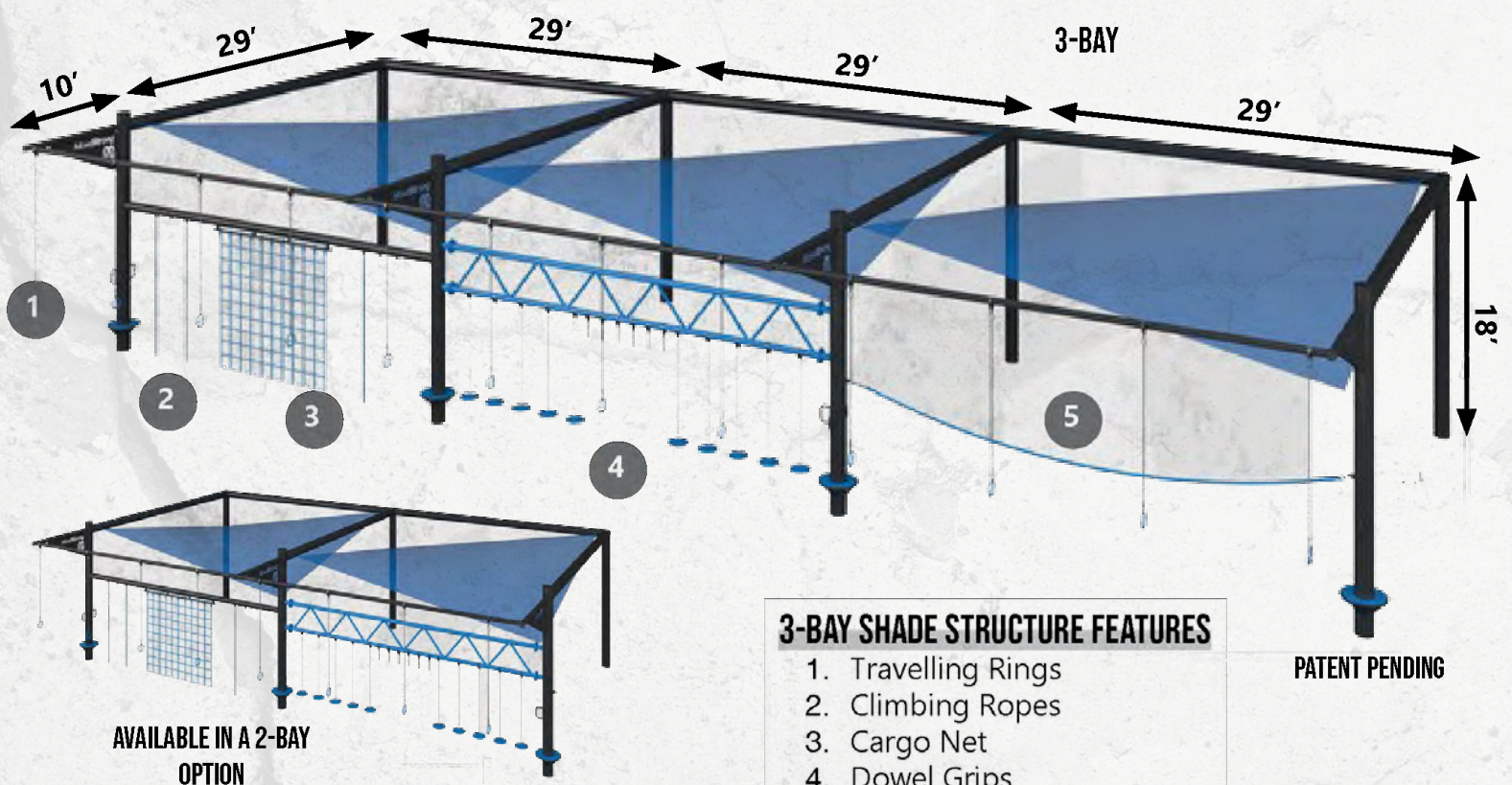

SURFACES AND SHADE

TRAINING PLACARDS & SIGNAGE



Elevate Trainer

Press

1. Stance with feet Hip width apart
2. Face away from post, arms extended holding handles
3. More body angle = More difficulty
4. Maintain straight body and lower towards handles, press-up to return

Rear

1. Stance with feet Hip width apart
2. Hold handles with arms extended
3. More body angle = More difficulty
4. Maintain straight body and pull towards handles
5. Lower back to start with control

Lunge

1. Stance with feet Hip width apart
2. Hold handles at chest
3. Lunge back with one leg while extending arms
4. Return and repeat with opposite leg

https://m.movestrongfit.com

MoveStrong
Live Life. Move Strong.
Staircase & Ramp

USE AT YOUR OWN RISK: Exercise instructions are for informational purposes only. Consult a physician before performing any exercise program. It is your responsibility to evaluate your own physical condition and determine whether to perform, use or adapt any of this exercise information. Any exercise program may result in injury, by voluntarily undertaking any exercise displayed, you assume the risk of any resulting injury.

Functional Staircase

Lateral Stairs

1. Turn laterally to stairs
2. Squat slightly and maintain quarter squat position as you move and down stairs laterally

Lunge Stairs

1. Lung up stairs skipping steps to achieve full lunge
2. Walk back down stairs and repeat

Staircase Heels

1. Start at base in Athletic Stance
2. Hop with both feet to next step
3. Skip steps to increase challenge

https://m.movestrongfit.com

MoveStrong
Live Life. Move Strong.
Staircase & Ramp

USE AT YOUR OWN RISK: Exercise instructions are for informational purposes only. Consult a physician before performing any exercise program. It is your responsibility to evaluate your own physical condition and determine whether to perform, use or adapt any of this exercise information. Any exercise program may result in injury, by voluntarily undertaking any exercise displayed, you assume the risk of any resulting injury.

Tire Flip

1. Start with feet shoulder-width apart
2. Squat down to grasp under tire with hands just outside shoulder width
3. Maintain a straight back and initiate tire lift with legs
4. Drive tire upwards with legs and arms straight
5. Cross legs and nearly fully extended adjust hands to push the tire up the remaining way
6. Push tire up and over to the other side

Advanced Fitness Obstacle
WARNING: Do not perform if you have back pain

https://m.movestrongfit.com

MoveStrong
Live Life. Move Strong.
FITGROUND

USE AT YOUR OWN RISK: Exercise instructions are for informational purposes only. Consult a physician before performing any exercise program. It is your responsibility to evaluate your own physical condition and determine whether to perform, use or adapt any of this exercise information. Any exercise program may result in injury, by voluntarily undertaking any exercise displayed, you assume the risk of any resulting injury.

NEW

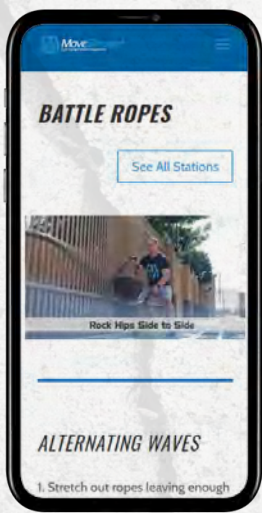

MOBILE TRAINER

Works on any mobile device, no need to download another fitness app. In moments of arrival your customers can refer to the instructional decal or quickly scan the QR code and start watching the instructional videos. We work with several fitness professionals to constantly update the exercise libraries so that your customers get the latest information on targeting their desired muscle groups. Stay up-to-date with our Mobile Trainer platform.

TRY ME



MOVESTRONG U



OUR COLLECTIVE OF RESOURCES IS AT YOUR DISPOSAL WITH MOVESTRONG U. LEARN FROM THE BEST AND PICKUP TIPS AND TRICKS FOR POWERFUL, FUNCTIONAL MOVEMENTS THAT WILL HELP YOU LIVE LIFE AND MOVE STRONGER EVERY DAY, TEACH BETTER EVERY DAY, AND MAKE THE MOST OF YOUR MOVESTRONG EQUIPMENT.

CUSTOMER VIDEO LIBRARY

Created for our customers to have instant access to 100's of MoveStrong™ product videos. Browse the video library to find exercise visuals per product, tips, workouts, promotional, and installation videos on many MoveStrong™ products.



CURRENT WORKSHOPS

Our hands-on courses teach the principles of functional strength/mobility, core stability, and biomechanics of human movement to maximize performance. For beginners to fitness professionals.

MOVE OF THE DAY

Pickup training tips and tricks of the trade with our extensive library of MoveStrong moves. For added benefits, subscribe to our Video Library to extend your knowledge base.

TRAINING EVENTS

Learn how to use the equipment, teach clients to use the equipment and make the most of your investment at our MoveStrong Training Events. You can even earn continuing education credits with some of our classes from leading accredited educators like ACE, NASM, and NSCA.

DESIGN & LAYOUT

Let our team assist with design and layout based on your space and needs. We offer surfacing recommendations for a safe and enjoyable FitGround. Customize with the exercise options desired to create your own station to accommodate different users' fitness and skill levels. Ideal for fitness bootcamps, group training classes, schools, obstacle courses, parks, military, or just a cool backyard adult fitness jungle gym!

Original Design

Final Build

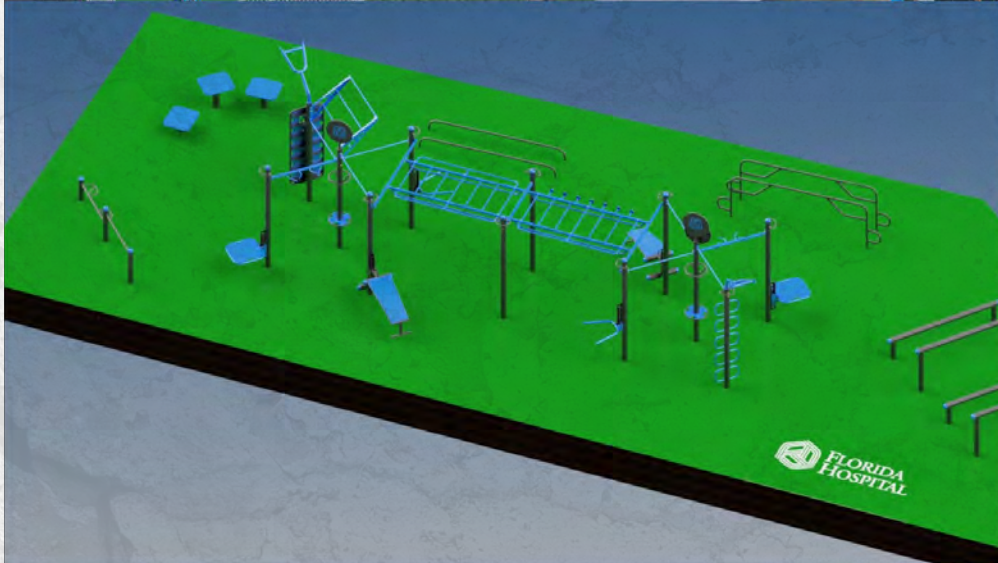

HAPPY CUSTOMERS

Visit Our Website For More Customer References and Pictures

Educational Institutions

- NC State University
- Oakwood University
- Vanguard University
- Fontana Unified Schools
- Bergen County Academies
- Soddy Daisy Middle School
- Ole Miss University
- Santa Clara University
- Savannah College of Art & Design
- Southern Illinois University
- Pitt University
- Purdue University
- Santa Clara Unified Schools

Military and First Responders

- Fort Polk AB
- Patrick AFB
- Robins AFB
- Columbus AFB
- Ft Bragg
- Ft Belvoir
- US Coast Guard Training Center Yorktown
- New Hanover County Sheriff's Department
- Montgomery County Law Enforcement Training Center

Religious Community Centers

- Hagerstown YMCA
- Tri-County YMCA
- Tampa YMCA
- Cincinnati YMCA

- Foothills YMCA
- Bridgewater JCC

Municipality / Parks and Recreation

- City of Bartlesville
- City of Castle Rock
- City of Round Rock
- Park City
- Pompano Beach
- Paradise Coast

Corporate Wellness

- Calera
- Pfizer

Community Living

- Oasis
- The Haven
- Eagle Crossing

Fitness Centers / Health Clubs

- Ellis Athletic Center
- Onslow Fitness
- Fitness 1440
- In-Shape
- Club EZ Fit
- Banks Dee Sports Club
- Steel Fitness Health & Wellness
- Mountain Valley Fitness & Health
- Retro Fitness
- O2 Fitness
- PowerHouse Gym

Resorts / Hotels

- Peninsula Papagayo Costa Rica
- Crown Plaza Baton Rouge
- LOCALE Cayman Islands
- Ocean's Edge Resort

HARDWARE & EQUIPMENT WARRANTIES



OUTDOOR FITNESS EQUIPMENT WARRANTY

Applies to all MoveStrong equipment designated and specifically manufactured for year round outdoor use.

MoveStrong provides a fifteen-year warranty on metal decks, pipes, rails, loops, and rungs; a lifetime limited warranty on upright posts; and a one-year warranty on the powder coating. These warranties cover damage due to failure or corrosion of metal parts that cause the product to become structurally unfit for its intended use. The lifetime warranty refers to the life of the product and covers the product under normal use and proper maintenance.

LIFETIME LIMITED WARRANTY ON HARDWARE

MoveStrong provides a lifetime limited warranty against structural failure due to breaking or shearing which causes the product to become structurally unfit for its intended use; a lifetime limited warranty on stainless steel hardware against rust; and a one-year limited warranty on non-stainless steel hardware against rust;. The lifetime warranty refers to the life of the product as defined below and covers the product under normal use and proper maintenance. The cost of replacement due to scratching or cutting of certain hardware plating is not included in this warranty.





2288 GUNBARREL ROAD STE 154/285
CHATTANOOGA, TN 37421
TOLL FREE (855) 728-8700
MOVESTRONGFIT.COM

